

Handlauf Edelstahl Ø 25mm

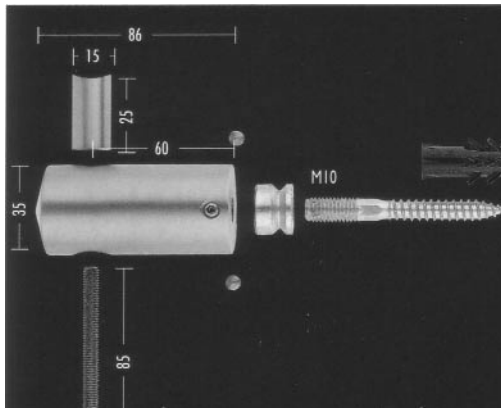

Art. Nr.	Bezeichnung	VE	incl.	Preis exkl. MWSt.
309-15031110	Handlauf Länge 3000mm	1	50,00	41,67



309-15031120	Wandkonsole mit Rohrträger incl. Montageset		66,50	55,42
--------------	---	--	-------	-------

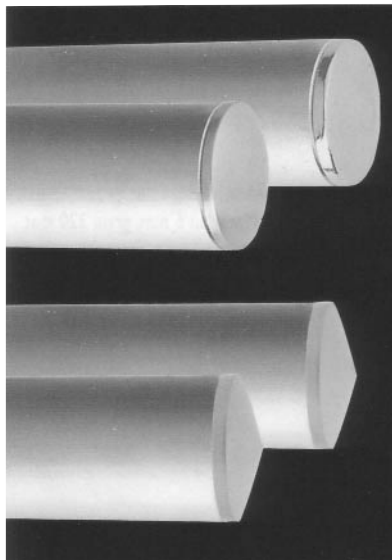

Endkappen				
309-15031140	Edelstahl stumpfer Kegel	1	25,20	21,00
309-15031130	Edelstahl rund	1	25,20	21,00
309-15031160	Messing poliert stumpfer Kegel	1	25,80	21,50
309-15031150	Messing poliert rund	1	25,80	21,50

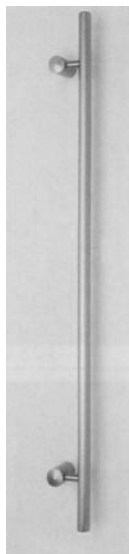

Auch als Stossgriff verwendbar!.

Handlauf Edelstahl



Art. Nr.	Bezeichnung	VE	incl.	Preis exkl. MWSt.
----------	-------------	----	-------	----------------------

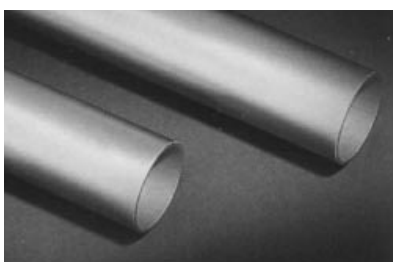

Handlauf Ø 42,4 x 2mm

309-15030260
309-15030190

Länge 6000mm
Länge 3000mm

1

83,00
45,70

69,17
38,08

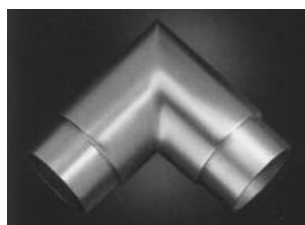

309-15031770

Winkelstück 90°

35,20

29,33



309-15031870

Eckstück

38,00

31,67

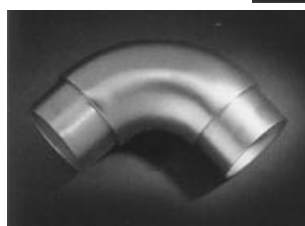

309-15031730

Bogen 90°

34,50

28,75

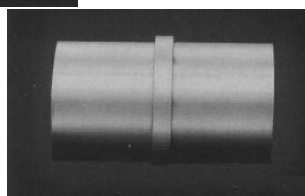

309-15033740

Rohrverbinder

10,80

9,00

Große Auswahl an andere Trägern und Verbindungen auf Anfrage.

Handlauf Edelstahl

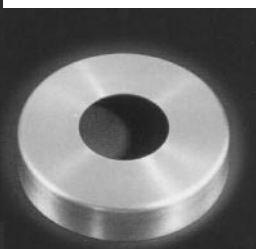
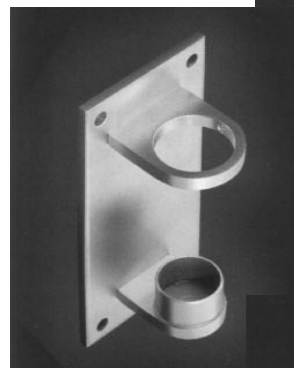

Art. Nr.	Bezeichnung	VE	incl.	Preis exkl. MWSt.
309-15030150	Rohrverbinder		18,20	15,17
309-15034020	Gelenkstück bis 90°		52,50	43,75
309-15033990	Doppelgelenk bis 180°		79,00	65,83
309-15034030	Seitenplatte 90°		44,50	37,08
	Rohr-Endkappen gerade			
309-15030100	Edelstahl		6,80	5,67
309-15030480	Messing poliert unlackiert		11,80	9,83
	Rohr-Endkappen gerundet			
309-15030120	Edelstahl		8,50	7,08
309-15030490	Messing poliert unlackiert		13,30	11,08
309-15033970	Anschraubplatte		41,00	34,17
309-15030050	Abdeckrosette		11,50	9,58
309-15030060	Wand- und Bodenanker		37,50	31,25

Handlauf Edelstahl

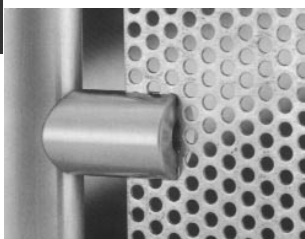
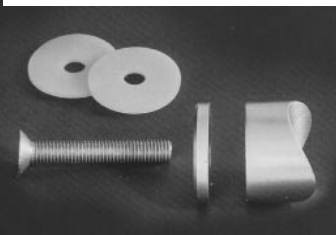
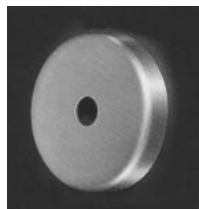
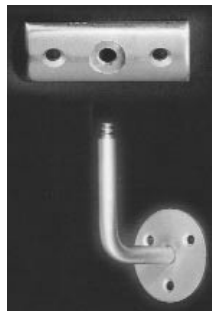

Art. Nr.	Bezeichnung	VE	incl.	Preis exkl. MWSt.
309-15030070	Anschraubplatte		8,40	7,00
309-15031080	Rohrträger starr		48,00	40,00
309-15031090	Rohrträger mit Gelenkstück		54,50	45,42
309-15031560	Rohrträger mit Gelenkstück		53,50	44,58
309-15032920	Handlaufträger		25,50	21,25
309-15030030	Anschraubplatte		4,40	3,67
309-15030010	Handlaufträger		14,30	11,92
309-15030040	Abdeckrosette		7,60	6,33
309-15030090	Glashalter		22,00	18,33
309-15030750	Glashalter für 8mm Glas		15,00	12,50
309-15033920	Blechhalter		39,00	32,50

Große Auswahl an andere Trägern und Verbindungen auf Anfrage.