

Regalbausystem



Oberflächen:

Lagernd: Edelstahl und Silber matt
innerhalb 5 Werktagen: Silber glänzend, Gold glänzend

Attraktiv im Design, solide in der Konstruktion, perfekt in der Oberfläche. Mit diesem System lassen sich Ihre Gestaltungsideen optimal und wirtschaftlich umsetzen.

Das System besteht im wesentlichen aus einem Leichtmetall-Rohrprofil mit konzentrischem Hohlzylinder für ein Innengewinde. Alle Profile werden in maßgefertigten Längen geliefert und mit funktionsbezogenen Zubehörteilen ergänzt.

Ob **Glas, Acryl, Holz oder Stein**, alles lässt sich über eine Lochbohrung im Material sicher mit den Profilen verbinden und problemlos mit Gewindestift oder Schraube befestigen.

Das Rohrprofil gibt es lagernd in den Ø 25, 35, und 50mm;
innerhalb von 5 Werktagen auch in Ø 20mm

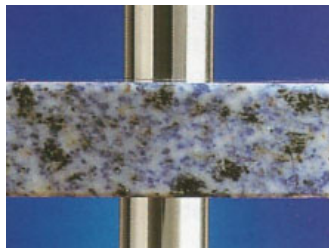
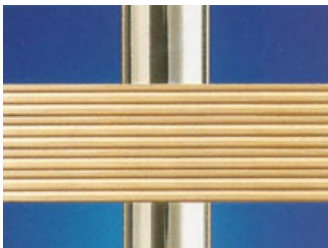
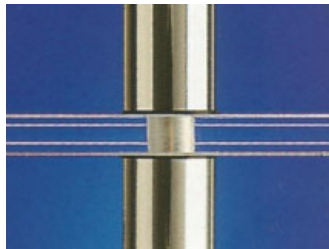
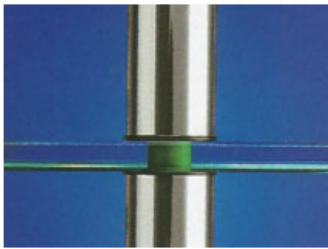

Regalbausystem

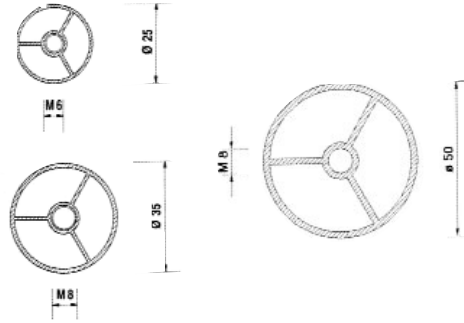
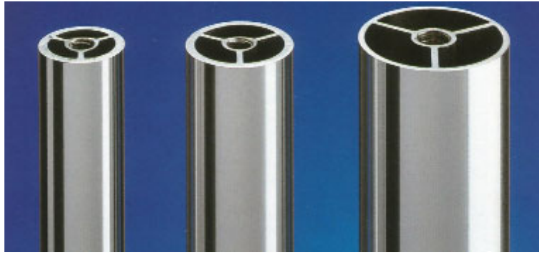

Art. Nr.	Bezeichnung	VE	incl.	Preis exkl. MWSt.
----------	-------------	----	-------	----------------------

Rohrprofil

Stangenlänge 3m

Preise im Zuschnitt/Meter mit Gewindefräsung

423-250001	Ø 25mm silber matt	27,40	22,83N
423-250002	Ø 25mm Edelstahl	36,70	30,58N
423-350001	Ø 35mm silber matt	30,-	25,00N
423-350002	Ø 35mm Edelstahl	40,80	34,00N
423-500001	Ø 50mm silber matt	45,80	38,17N
423-500002	Ø 50mm Edelstahl	54,-	45,00N



Gewindestift

423-250110	M6x25	-,35	-,29N
423-250140	M6x40	-,50	-,42N
423-350110	M8x25	-,50	-,42N
423-350140	M8x40	-,80	-,67N

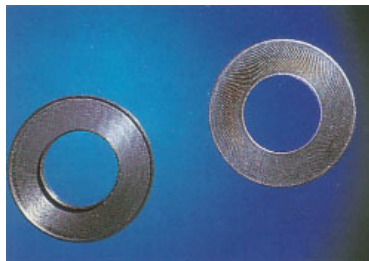

Beilagscheibe

Kunststoff transparent

423-250210	für Ø 25mm	-,40	-,33N
423-350210	für Ø 35mm	-,40	-,33N
423-500210	für Ø 50mm	1,-	-,83N



Flachrosette

für M6/M8 Gewindestift

423-250411	Ø 25mm silber matt	6,80	5,67N
423-250412	Ø 25mm Edelstahl	9,-	7,50N
423-350411	Ø 35mm silber matt	8,-	6,67N
423-350412	Ø 35mm Edelstahl	11,60	9,67N
423-500411	Ø 50mm silber matt	10,20	8,50N
423-500412	Ø 50mm Edelstahl	15,40	12,83N

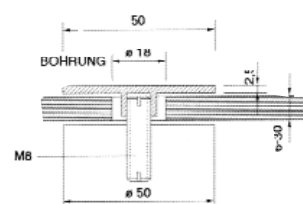
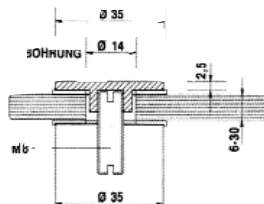
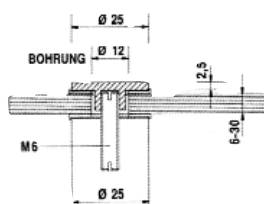

Regalbausystem



Art. Nr.	Bezeichnung	VE	incl.	Preis exkl. MWSt.
----------	-------------	----	-------	----------------------

Abschlussrosette

für M6/M8 Gewindestift

423-250551	Ø 25mm silber matt		5,-	4,67N
423-250552	Ø 25mm Edelstahl		7,80	6,50N
423-350551	Ø 35mm silber matt		6,60	5,50N
423-350552	Ø 35mm Edelstahl		9,20	7,67N



Fußrosette

für M6/M8 Gewindestift

423-250451	Ø 25mm silber matt		6,20	5,17N
423-250452	Ø 25mm Edelstahl		9,20	7,67N
423-350451	Ø 35mm silber matt		8,60	7,17N
423-350452	Ø 35mm Edelstahl		11,20	9,33N
423-500721	Ø 50mm silber matt		15,-	12,50N
423-500722	Ø 50mm Edelstahl		20,20	18,67N

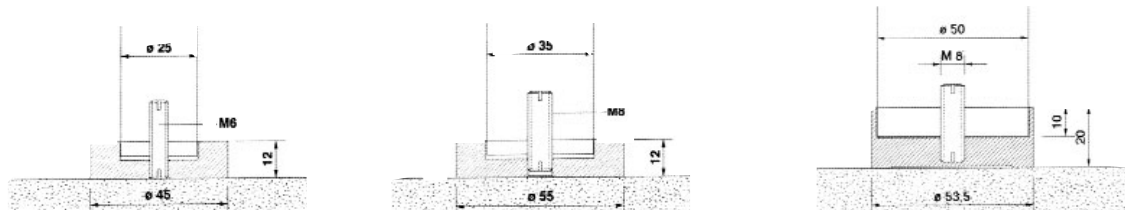

Montageplatte rund

mit M6/M8 Schraube

423-250671	Ø 25mm silber matt		8,60	7,17N
423-250672	Ø 25mm Edelstahl		15,-	12,50N
423-350671	Ø 35mm silber matt		9,80	8,17N
423-350672	Ø 35mm Edelstahl		15,80	13,17N
423-500672	Ø 50mm Edelstahl		22,40	18,67N

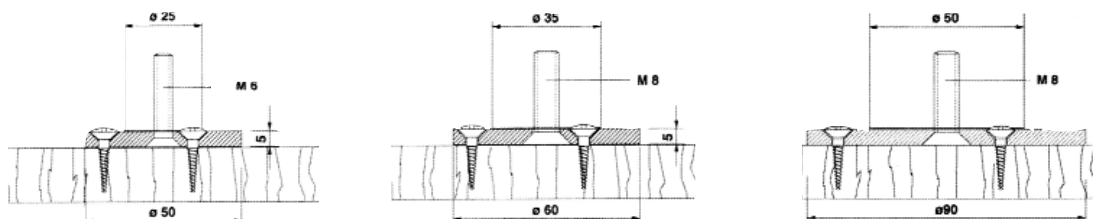

Regalbausystem

Art. Nr.	Bezeichnung	VE	incl.	Preis exkl. MWSt.
----------	-------------	----	-------	----------------------

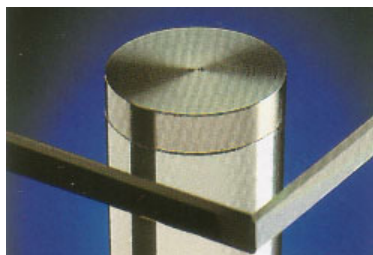

Rosette

Edelstahl für UV Glasverbindung

423-250902
423-350902
423-500902

für Ø 25mm
für Ø 35mm
für Ø 50mm

7,80
8,80
12,80

6,50N
7,33N
10,67N

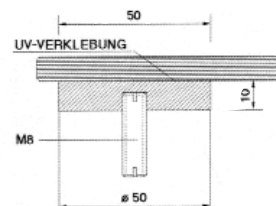
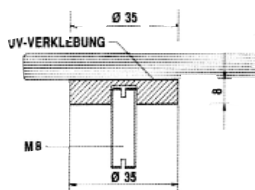
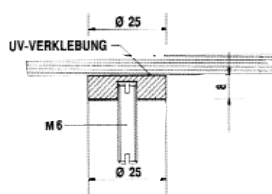

Deckenspanhalter

423-250491
423-250492

Ø 25mm silber matt
Ø 25mm Edelstahl

11,80
14,80

9,83N
12,33N

423-350491
423-350492

Ø 35mm silber matt
Ø 35mm Edelstahl

12,80
16,-

10,67N
13,33N

423-500491
423-500492

Ø 50mm silber matt
Ø 50mm Edelstahl

12,20
16,40

10,67N
13,67N

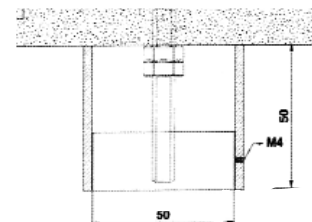
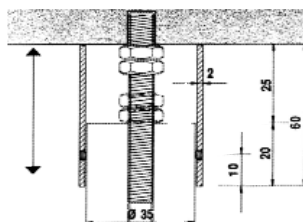
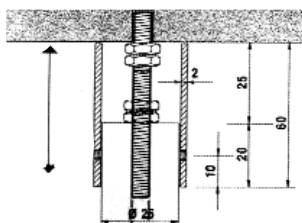

Weitere Zubehörteile auf Anfrage:

